



7548

3.3-kVA, DC-enabled Linear Power Amplifier

Performance Overview:

AC Power (up to 20 kHz):	3380 watts RMS
Small Signal:	28V p-p to 200 kHz
For High-Power Applications to:	50 kHz
40 ms Pulse (0.5Ω):	112 Ap
Slew Rate:	>35 V/μs
Output Voltage:	±200 Vp
Output Impedance:	3.2 mΩ in series with 2.2 μH

AE Techron's **7548** amplifier is a 3300-VA, DC-enabled, high-powered unit designed to provide very low noise, low harmonic distortion and fast slew rates. It can safely drive a wide range of resistive, inductive loads.

Typical use includes as a power source for EMC testing in applications that require both continuous AC or DC signals and significant short term (burst) signals. Two 7548 connected in series can output 240V RMS at 20A RMS. The 7548 can be used singly or in series to meet or exceed Aviation AC power tests requirements found in RTCA/DO 160.

The 7548 also can be used as a Voltage or Current Amplifier, so it also makes an ideal choice for driving large Helmholtz coils specified in MIL STD 461 or various Automotive Standards.

In addition, the 7548 can be connected to form large, low-distortion, two- or three-phase power systems with voltages of up to 600V L-L and 360 L-N, ideal for MIL-STD-704F (AC and 28V DC tests).

Features

- Four-quadrant operation (source and sink).
- Field-selectable controlled-voltage or controlled-current modes of operation
- Over 12,000 watts peak for 40 ms and 5,500 watts peak continuous into a 1-ohm load
- Continuous system output of 800 Vp or 170 Ap are possible with multiple, interconnected amplifiers
- Can be combined to form larger, more capable systems: Single-phase AC system with DC offset capable of 120VAC, 240VAC or 360VAC, or three-phase AC system with DC offset capable of 208VAC, 400VAC or up to 600VAC L-L
- Can be switched between rail supply modes to optimize for various load impedances
- Protection circuitry protects the amplifier from input overloads, improper output connection (including shorted and improper loads), over-temperature, over-current, and supply voltages that are too high or low

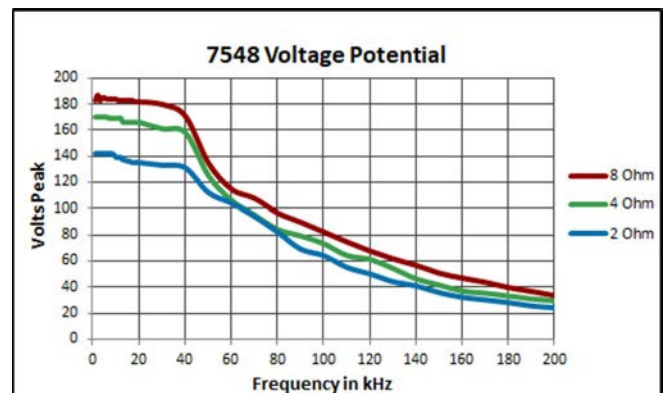

Specifications

Performance

Testing performed at 208V/415V AC. 7548 amplifiers can operate from 400V AC $\pm 10\%$. Since these amplifiers have an unregulated power supply, low line conditions may slightly affect the maximum voltage potential. All testing was performed in Controlled-Voltage (CV) mode. Accuracy was measured when driven into a 10-ohm load with between 0.1V DC and 6V DC or between 0.2V AC and 5V AC presented at its inputs.

Frequency Response, DC–30 kHz (1 watt): +0.1 to -0.5 dB

8-Ohm Power Response (continuous duty),

DC to 40 kHz: ± 180 Vpk

DC to 50 kHz: ± 150 Vpk

DC to 150 kHz: ± 50 Vpk

DC to 200 kHz : ± 25 Vpk

Maximum Continuous Output Power: 3300 watts RMS

Slew Rate: >35 V/ μ Sec

Residual Noise, 10 Hz to 20 kHz: <250 μ V (<0.25 mV)

Unit to Unit Phase Error: ± 0.1 degrees at 60 Hz

Phase Response (10 Hz - 10 kHz): ± 5 degrees plus 600 nsec propagation delay

THD (DC - 20 kHz): $<0.25\%$

Output Offset: $<\pm 200$ μ V

Output Offset Current: <10 mA, DC

DC Drift,

From Cold to Maximum Operating Temperature: $<\pm 400$ μ V

After 20 Minutes of Operation: ± 200 μ V

Output Impedance: 3.2 m Ω in Series with 2.2 μ H

Input Characteristics,

Balanced with ground: Three-terminal barrier-block connector, 20 k Ω differential

Unbalanced: BNC connector, 10 k Ω single-ended

Gain:

Voltage Mode: 20 volts/volt

Current Mode: 20 amperes/volt

Gain Linearity (over input signal, from 0.2V to 5V):

DC: 0.0125%

AC: 0.030%

Max Input Voltage: ± 10 V, balanced or unbalanced

Input Impedance: 20 k Ω differential

Common Mode Rejection Range: ± 11 V DC maximum

Common Mode Rejection Ratio: Better than -65 dB

Status Display, Control, I/O

Front Panel LED Displays indicate: Ready, Standby, Fault

Soft Touch Switches for: Run, Stop, Reset

LCD Display: Can be configured for up to four simultaneous displays reporting one, two, or all four of the following: V_p , V_{RMS} , A_p , A_{RMS} . Also reports any fault conditions that occur and suggests corrective action.

Back Panel Power Connection: NEMA-style locking receptacle; matching AC connector also included

Signal Output: 4-position terminal barrier block (OUTPUT / COMMON / SAMPLED COMMON / CHASSIS GROUND); resistor installed between SAMPLED COMMON AND CHASSIS GROUND is a 2.7-ohm, 2W, 5%, metal-oxide resistor

Signal Input: User-selectable BNC or Barrier Strip, Balanced or Unbalanced

Interlock Connector: 25-pin D-sub connector used for amplifier control and status applications; also used in multi-amplifier applications

Communication Capabilities

Current Monitor: 20A/V $\pm 1\%$; 10A/V $\pm 1\%$ (differential configuration)

Reporting: System Fault, Over Temp, Over Voltage, Over Load

Remote Control via Interlock Connector: Force to Standby, Reset after a Fault

Protection

Over/Under Voltage: $\pm 10\%$ from specified supply voltage amplifier is forced to Standby

Over Current: Breaker protection on both main power and low-voltage supplies

Over Temperature: Separate output transistor, heat sink, and transformer temperature monitoring and protection

Physical Characteristics

Chassis: The amplifier is designed for stand-alone or rack-mounted operation. The chassis is aluminum with a black powder-coat finish. The unit occupies five EIA 19-inch-wide units.

Weight: 103 lbs (46.7 kg), Shipping 115 lbs (52.2 kg)

AC Power: Three-phase, 208V AC ($\pm 10\%$), 47-60 Hz, 20A AC service; (400V AC ($\pm 10\%$), 15A model available)

Operating Temperature: 10°C to 50°C (50°F to 122°F), maximum output power de-rated above 30°C (86°F.)

Humidity: 70% or less, non-condensing

Cooling: Forced air cooling from front to back through removable filters via four 100ft³/min. fans. No space is required between rack-mounted amplifiers. Air filters are removable from the rear via one fastener per side and may be eliminated if cabinet filtration is provided.

Dimensions: 19" x 22.8" x 8.75" (48.3 cm x 57.9 cm x 22.2 cm)

AC Output

Ohms	PEAK OUTPUT						RMS OUTPUT					
	40 mSec Pulse, 20% Duty Cycle		5 Minutes, 100% Duty Cycle		1 Hour, 100% Duty Cycle		5 Minutes, 100% Duty Cycle		1 Hour, 100% Duty Cycle			
	Volts	Amps	Volts	Amps	Volts	Amps	Volts	Amps	Volts	Amps	Watts	
Open	200	0	200	0	200	0	141	0	141	0	0	
16	195	12	195	12	195	12	138	8	138	8	1170	
8	183	23	18	23	183	23	129	16	129	16	2104	
4	165	41	165	41	165	41	117	29	117	29	3381	
2	150	75	*	*	86	43	*	*	61	30	1848	
1.5	134	90	*	*	*	*	*	*	*	*	*	
1	116	105	*	*	*	*	*	*	*	*	*	
0.5	66	112	*	*	*	*	*	*	*	*	*	

Note: Testing performed into resistive loads as specified. Performance reported is typical into the specified load up to 20 kHz frequency levels. Performance may be affected when operating into highly reactive loads or above 20 kHz, reducing maximum voltage, current and power output.

* Testing not performed.

DC Output

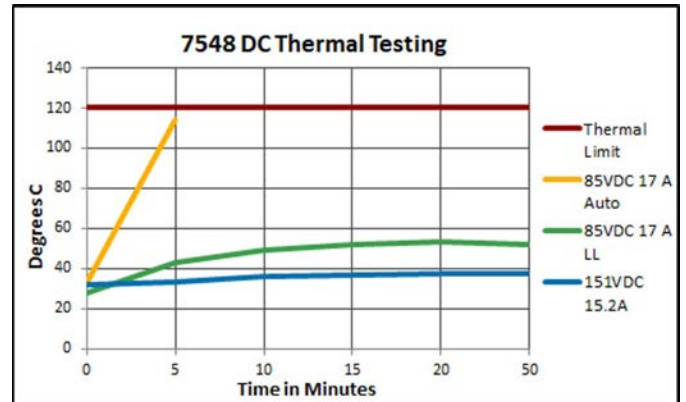
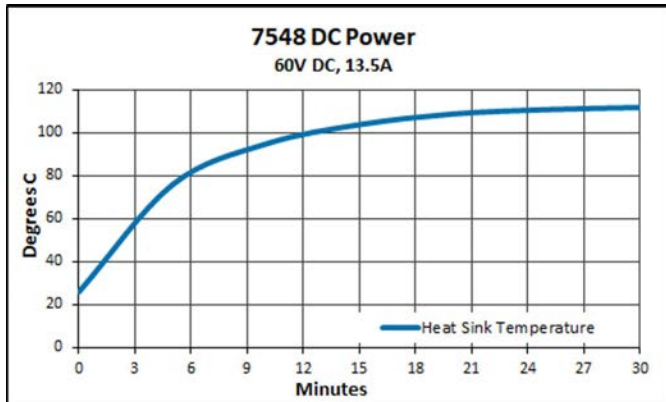

Performance

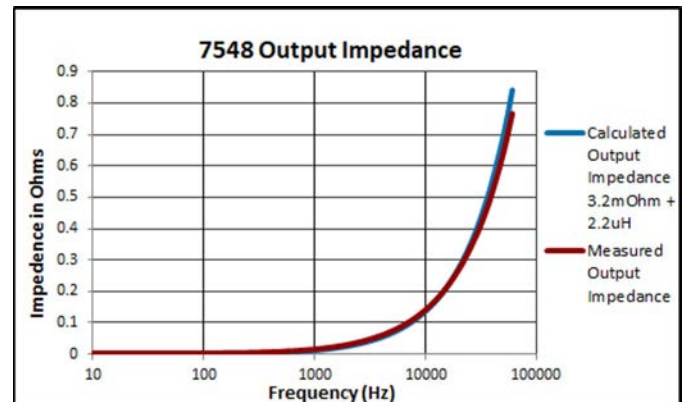
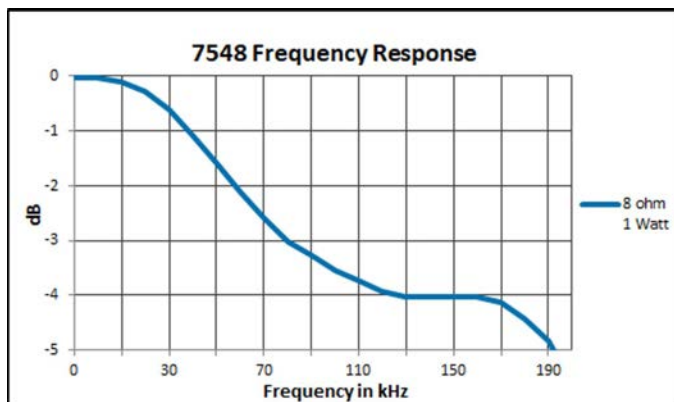

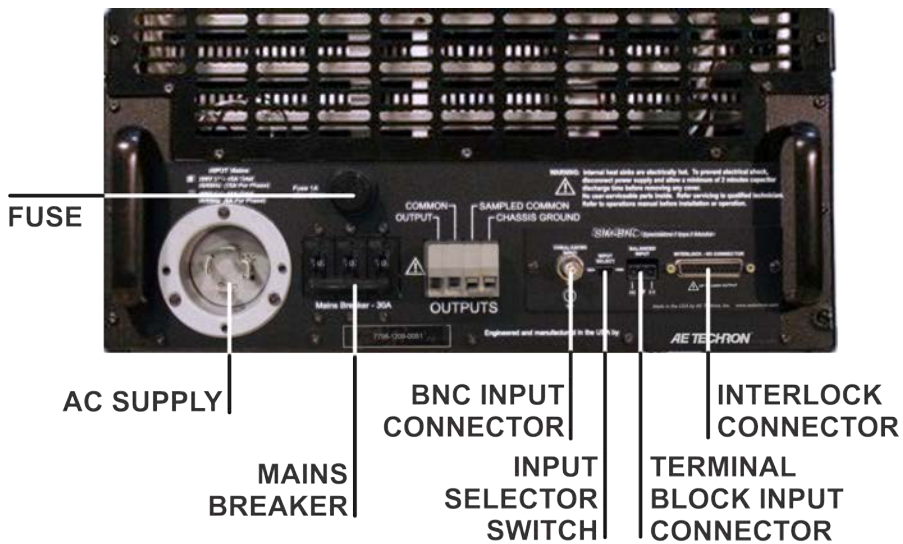
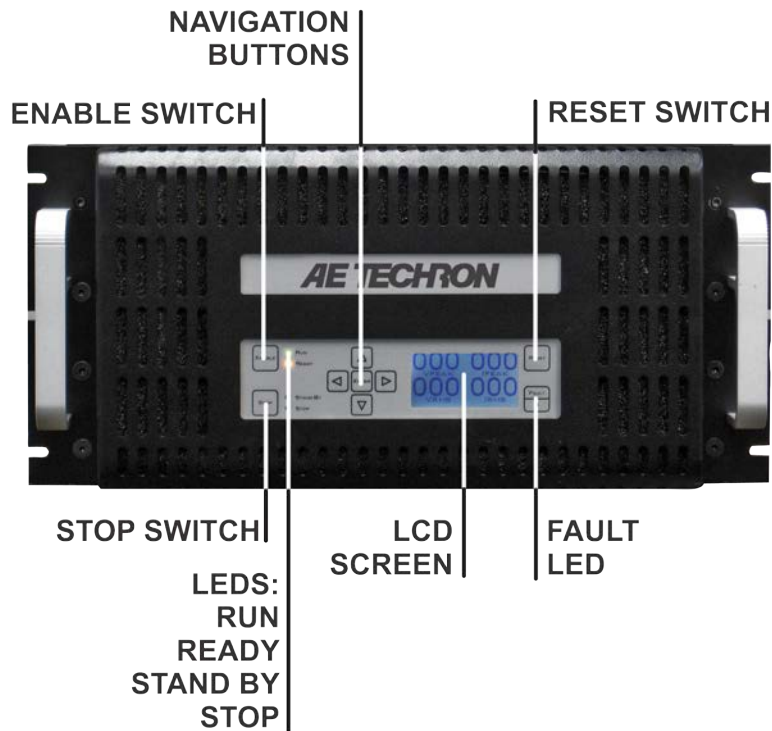

CE 400V versions of this product bear the CE mark

AE Techron Sales Representative