

- Single Slot Battery Simulator
- Remote Voltage Sense
- Isolated Outputs
- Output Voltage Up To 6V
- Power Supplied From PXI Backplane
- Programmable Output Resistance
- Programmable Current Sink Capability To 0.5A For Charger Load Simulation
- VISA and Kernel Drivers Supplied For Windows Plus Soft Front Panel
- Supported by PXI or LXI Chassis



The 41-753 is a battery simulator module that can be used to simulate the power supplies of cellular phones and other portable battery devices. It features fully floating output terminals that can deliver up to 6V. The fast responding remote sense connections allow the module to regulate the supply voltage at the device under test. The output terminals can float  $\pm 50V$  relative to the front panel ground to ensure the accurate simulation of battery operation.

The module can source or sink current to simulate a battery supply or a battery under charge. The programmable current sink can be set to divert up to 0.5A of the load current, permitting the battery simulator to act as a net current sink when connected to a charger circuit. The 41-753 is capable of delivering up to 2.8A.

The output resistance can be programmed up to 1.15 $\Omega$  to simulate the effect of battery output resistance when connected to time varying loads.

The module derives its power from the PXI backplane and requires no external power source.

It can be configured so that if the remote sense lines are not connected to the device under test, the power supply is automatically closed down. The alternative configuration regulates the voltage at the front panel connector if the sense lines are not connected to the load.

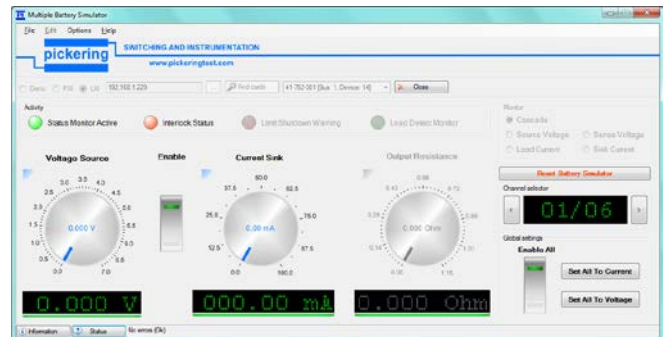

Soft Front Panel for Battery Simulator Modules

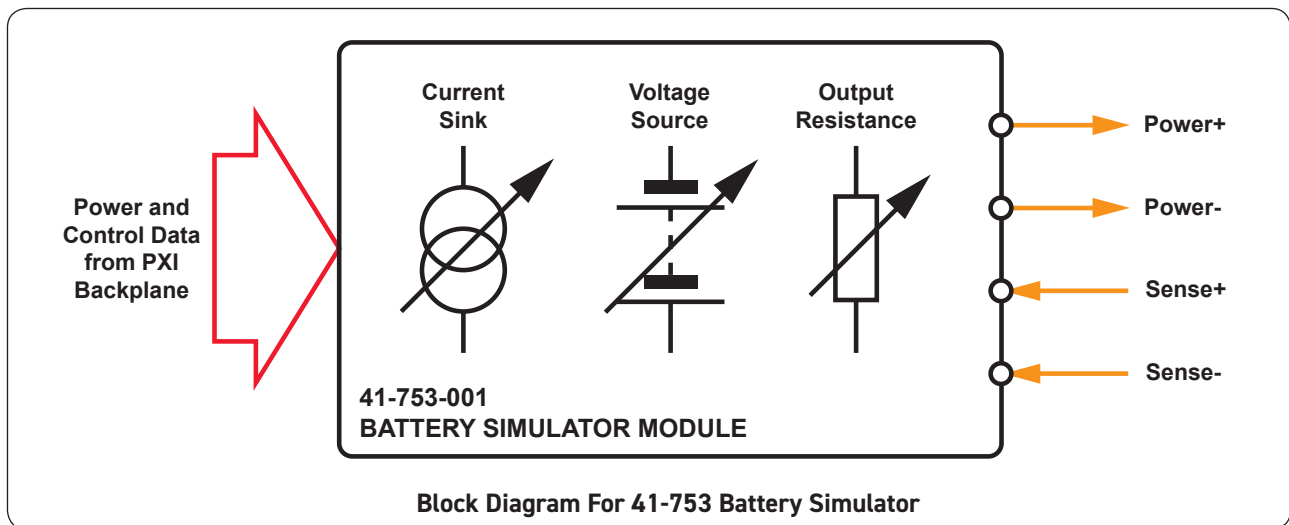

Block Diagram For 41-753 Battery Simulator

ISSUE 2.4 APR 2018

## Specification

Number of Channels:	1 (isolated)
Output Voltage Range:	0 to 6 Volts (at front panel), isolated $\pm 50V$ maximum common mode voltage.
Voltage Resolution:	Set with 16-bit resolution.
Voltage Sense:	Remote sensing of load voltage, mechanically configurable to either regulate front panel voltage or close down if not connected.
Output Current:	Up to 2.8 Amps at 5.5V Up to 2.5 Amps at 6V (includes set sink current).
Output resistance:	Programmable from 0 $\Omega$ to 1.15 $\Omega$
Current Sink:	Programmable current sink from 0 to 0.5 Amps available for output voltages above 0.5V. Current sink setting reduces the available maximum output current delivered to the load if an external current source is not applied.
Load Response Time:	15 $\mu s$ (1A to 2A, 2m connection wire, using all connection pins).
Power Source:	PXI backplane +5V.
Monitor:	Provided through monitor pins to measure output voltages and current. Can be used to measure load voltage, front panel voltage, load current and sink current. Current is measured by voltage sensing across a resistor.
Monitor Accuracy:	Voltage DMM $\pm 30\mu V$ Current 1% $\pm 1mA$ (after zero correction).
Load Detection:	Read back flag indicates if load is drawing more than 10mA.
Protection:	Short circuit protection. Thermal protection. Operation of protection is reported. Prolonged operation of protection is not recommended.
Output Connector:	25-pin male D-type. Each connection is supported by two pins to permit doubling up of connections.

## Power Requirements

+3.3V	+5V	+12V	-12V
0.2A	6A	0.15A	0.1A

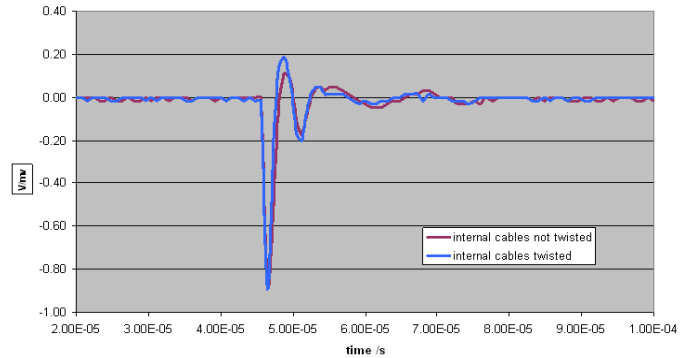

**Typical load transient response of 41-753 for 6V output when load is changed abruptly from 1A to 2A in  $\ll 1\mu s$**

## Mechanical Characteristics

Single slot 3U PXI (CompactPCI card).

3D models for all versions in a variety of popular file formats are available on request.

## Connectors

PXI bus via 32-bit P1/J1 backplane connector.

Signals via front panel 25-pin male D-type connector, for pin outs please refer to the operating manual.

## Operating/Storage Conditions

### Operating Conditions

Operating Temperature:	0°C to +55°C
Humidity:	Up to 90% non-condensing
Altitude:	5000m

### Storage and Transport Conditions

Storage Temperature:	-20°C to +75°C
Humidity:	Up to 90% non-condensing
Altitude:	15000m

## PXI & CompactPCI Compliance

The module is compliant with the PXI Specification 2.2. Local Bus, Trigger Bus and Star Trigger are not implemented.

Uses a 33MHz 32-bit backplane interface.

## Safety & CE Compliance

All modules are fully CE compliant and meet applicable EU directives: Low-voltage safety EN61010-1:2010, EMC Immunity EN61326-1:2013, Emissions EN55011:2009+A1:2010.\*

## Product Order Codes

---

<b>Battery Simulator, 2.8 Amps</b>	<b>41-753-001</b>
------------------------------------	-------------------

---

## Product Customization

Pickering PXI modules are designed and manufactured on our own flexible manufacturing lines, giving complete product control and enabling simple customization to meet very specific requirements.

All customized products are given a unique part number, fully documented and may be ordered at any time in the future. Please contact your local sales office to discuss.

## Mating Connectors & Cabling

---

For connection accessories for the 41-753 module please refer to the [90-008D](#) 25-pin D-type Connector Accessories data sheet where a complete list and documentation can be found for accessories, or refer to the Connection Solutions catalog.

---

## Chassis Compatibility

This PXI module must be used in a suitable chassis. It is compatible with the following chassis types:

- All chassis conforming to the 3U PXI and 3U Compact PCI (cPCI) specification
- Legacy and Hybrid Peripheral slots in a 3U PXI Express (PXIe) chassis
- Pickering Interfaces LXI or LXI/USB Modular Chassis

## Chassis Selection Guide

### Standard PXI or hybrid PXIe Chassis from any Vendor:

- Mix our 1000+ PXI switching & simulation modules with any vendor's PXI instrumentation
- Embedded or remote Windows PC control
- Real-time Operating System Support
- High data bandwidths, especially with PXI Express
- Integrated module timing and synchronization



### Pickering LXI or LXI/USB Modular Chassis—only accept our 1000+ PXI Switching & Simulation Modules:

- Ethernet or USB control enables remote operation
- Low-cost control from practically any controller
- LXI provides manual control via Web browsers
- Driverless software support
- Power sequencing immunity
- Ethernet provides chassis/controller voltage isolation
- Independence from Windows operating system



## Connectivity Solutions

We provide a full range of supporting cable and connector solutions for all our switching products—20 connector families with 1200+ products. We offer everything from simple mating connectors to complex cables assemblies and terminal blocks. All assemblies are manufactured by Pickering and are guaranteed to mechanically and electrically mate to our modules.

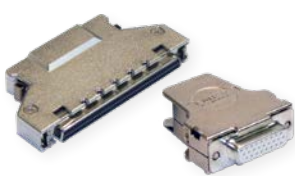

Connectors & Backshells



Multiwire Cable Assemblies

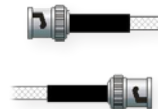

RF Cable Assemblies



Connector Blocks

We also offer customized cabling and have a free online Cable Design Tool that can be used to create custom cable solutions for many applications.

Visit: [pickeringtest.com/cdt](http://pickeringtest.com/cdt) to start your design.

### Mass Interconnect

We recommend the use of a mass interconnect solution when an Interchangeable Test Adapter (ITA) is required for a PXI or LXI based test system. Our modules are fully supported by both Virginia Panel and MacPanel.

### Pickering Reed Relays

We are the only switch provider with in-house reed relay manufacturing capability via our sister company, Pickering Electronics. These instrument grade reed relays feature **SoftCenter®** technology, ensuring long service life and repeatable contact performance

To learn more, please go to: [pickeringrelay.com](http://pickeringrelay.com)



## Programming

Pickering provide kernel, IVI and VISA (NI & Keysight) drivers which are compatible with all Microsoft supported versions of Windows and popular older versions. For a list of all supporting operating systems, please see: [pickeringtest.com/os](http://pickeringtest.com/os)

The VISA driver is also compatible with Real-Time Operating Systems such as LabVIEW RT. For other RTOS support contact Pickering. These drivers may be used with a variety of programming environments and applications including:

- **Pickering Interfaces Switch Path Manager**
- **National Instruments** products (LabVIEW, LabWindows/CVI, Switch Executive, MAX, TestStand, VeriStand, etc.)
- **Microsoft Visual Studio** products (Visual Basic, Visual C+)
- **Keysight** VEE
- **Mathworks** Matlab
- **Marvin** ATEasy
- **MTQ Testsolutions** Tecap Test & Measurement Suite

Drivers for popular Linux distributions are available, other environments are also supported, please contact Pickering with specific enquiries.

We provide Soft Front Panels (SFPs) for our products for familiarity and manual control, as well as comprehensive documentation and example programs to help you develop test routines with ease.

To learn more about software drivers and development environments, please go to: [pickeringtest.com/software](http://pickeringtest.com/software)

## Signal Routing Software

Our signal routing software, Switch Path Manager, automatically selects and energizes switch paths through Pickering switching systems. Signal routing is performed by simply defining test system endpoints to be connected together, greatly accelerating Test System software development.

To learn more, please go to: [pickeringtest.com/spm](http://pickeringtest.com/spm)

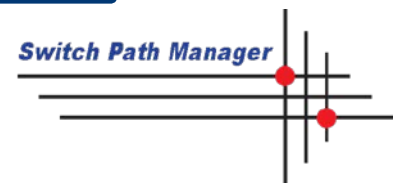

## Diagnostic Relay Test Tools

eBIRST Switching System Test Tools are designed specifically for our PXI, PCI or LXI products, these tools simplify switching system fault-finding by quickly testing the system and graphically identifying the faulty relay.

To learn more, please go to: [pickeringtest.com/ebirst](http://pickeringtest.com/ebirst)



## Three Year Warranty & Guaranteed Long-Term Support

All standard products manufactured by Pickering Interfaces are warranted against defective materials and workmanship for a period of three years from the date of delivery to the original purchaser. Extended warranty and service agreements are available for all our modules and systems with various levels to suit your requirements. Although we offer a 3-year warranty as standard, we also include guaranteed long-term support—with a history of supporting our products for typically 15-20 years. To learn more, please go to: [pickeringtest.com/support](http://pickeringtest.com/support)

## Available Product Resources

We have a large library of product resources including success stories, product and support videos, articles, as well as complete product catalogs and product reference maps to assist when looking for the switching, simulation and cable and connector solutions you need. We have also published handy reference books for the PXI and LXI standards.

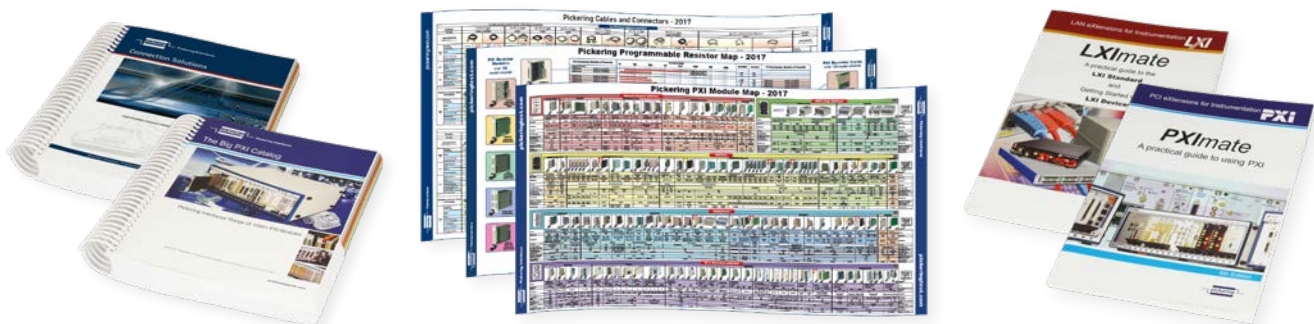

To view, download or request any of our product resources, please visit: [pickeringtest.com/resources](http://pickeringtest.com/resources)

© Copyright (2019) Pickering Interfaces. All Rights Reserved. Pickering Interfaces maintains a commitment to continuous product development, consequently we reserve the right to vary from the description given in this data sheet.